

Fenner

FENAFLEX TYRE COUPLINGS



POWERTRAN

Dependable Power Transmission Accessories

FENNER TYRE COUPLINGS



Fenner Tyre couplings provide all the desirable features of an ideal flexible coupling, including Taper-Lock® fixing. The Fenner Tyre coupling is a "torsionally elastic" coupling offering versatility to designers and engineers with a choice of flange combinations to suit most applications.

The flanges are available in either F or H version Taper-Lock® fitting or bored to size B.

With the addition of a spacer flange, the coupling can be used to accommodate standard distance between shaft ends and facilitate pump maintenance.

Fenner Tyre couplings can accommodate simultaneous maximum misalignment in all planes without imposing undue loads on adjacent bearings and the excellent shock-absorbing properties of the flexible tyre reduce vibrations and torsional oscillations.

Fenner tyres are available in natural rubber compounds for use in ambient temperatures between -50°C to +50°C. Neoprene rubber compounds are available for use in adverse operating conditions e.g. oil or grease contaminations and can be used in temperatures of -15°C to +70°C.

F.R.A.S. tyres are available for use when fire-resistance and antistatic (F.R.A.S.) properties are required.

TORQUE-BORE RANGE

The range includes couplings with torque capacity upto 12606 Nm. and bore diameters upto 190 mm.

MISALIGNMENT

Handles parallel, angular and axial displacements, either singly or in any combination. They can accommodate parallel misalignment upto 6 mm, angular misalignment upto 4° and end float upto 8 mm.

TORSIONALLY SOFT

Cushions against destructive shock loads protecting the complete system, preventing expensive breakdowns and lengthens machine life.

FREE OF BACKLASH

Does not create 'snatch' on take up of the drive.

INSTALLATION

Requires neither special tools nor skilled labour to assemble. Alignment is quickly checked by placing a straight edge across outside diameter of flanges. The split flexible tyre is then positioned in the flanges and the screws tightened into place.

DAMPING

Reduces vibration and torsional oscillations developed in internal combustion engines, the amplitude of which increases greatly at critical points in the speed range. Fenner Tyre coupling dampens these destructive vibrations.

MAINTENANCE

Because there are no moving parts, no lubrication is required. Periodic visual inspection of the tyre is all that is necessary.

EASY ELEMENT REPLACEMENT

To replace flexible element simply loosen the clamping screws, remove the tyre and replace with a new one. It is not necessary to move either driver or driven machine or coupling flanges.

ENVIRONMENT

Use of natural or Neoprene rubber compounds makes the Fenner Tyre coupling suitable for use in most conditions. For fire hazard areas the F.R.A.S. tyre is recommended. This allows free flow of electricity between the two shafts to avoid static electricity build up.

FENNER TYRE COUPLINGS - SELECTION



DETAILS REQUIRED FOR COUPLING SELECTION

1. Type of driven machine and operating hours per day.
2. Speed and power absorbed by driven machine (if absorbed power is not known, calculate on power rating of prime mover).
3. Diameters of shafts to be connected.

PROCEDURE

- a. **Service Factor** : Determine the required service factor from table 1.
- b. **Design Power** : Multiply the normal running power by the service factor. This gives the design power which is used as a basis for selecting the coupling.
- c. **Coupling Size** : Refer to table 3 (page 5) and from the appropriate speed, read across until a power greater than that required in step (b) is found.

The size of Fenner Tyre Coupling required is given at the head of that column.

- d. **Bore Size** : Check from dimension tables that chosen flanges can accommodate required bores.

EXAMPLE

A Fenner Tyre Coupling is required to transmit 45 kW from an A.C. Electric Motor which runs at 1440 rev/min to a rotary screen for 12 hours a day. The motor shaft is 60 mm diameter and the screen shaft is 55 mm diameter.

- a. **Service Factor** : From table 1, the service factor is 1.4.
- b. **Design Power** : Design Power = $45 \times 1.4 = 63$ kW.
- c. **Coupling Size** : By reading across from 1440 rev/min in table 3 (page 6) the first power figure to exceed the required 63 kW in step (b) is 76.1 kW. The size of coupling is F100.
- d. **Bore Size** : By referring to table 2 (page 5) it can be seen that both shaft diameters fall within the bore range available.

TABLE 1: SERVICE FACTORS

Special Cases	Type of Driving Unit					
	Electric Motors Steam Turbines			Internal Combustion Engines Steam Engines Water Turbines		
Type of Driven Machine	Operational hours per day					
	10 and under	Over 10 to 16 inclusive	over 16	10 and under	Over 10 to 16 inclusive	over 16
CLASS 1 Agitators, Brewing machinery, Centrifugal compressors and pumps, Belt conveyors, Dynamometers, Line shafts, Fans upto 7.5 kW, Blowers and Exhausters (except positive displacement), Generators.	0.8	0.9	1.0	1.3	1.4	1.5
CLASS 2 Clay working machinery, General Machine tools, Paper mill beaters and winders, Rotary pumps, Rubber extruders, Rotary screens, Textile machinery, Marine propellers and fans over 7.5 kW.	1.3	1.4	1.5	1.8	1.9	2.0
CLASS 3 Bucket elevators, Cooling tower fans, Piston compressors and pumps, Foundry machinery, Metal presses, Paper mill calendars, Pulverisers and Positive displacement blowers.	1.8	1.9	2.0	2.3	2.4	2.5
CLASS 4 Reciprocating conveyors, Gyratory crushers, Mills (ball, pebble and rod), Rubber machinery (Banbury mixers and mills) and Vibratory screens	2.3	2.4	2.5	2.8	2.9	3.0

FENNER TYRE COUPLINGS



F TYPE

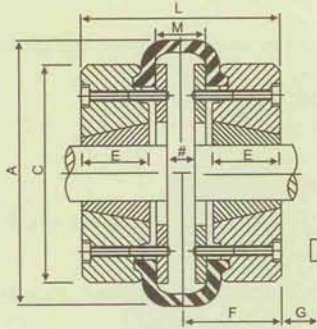

F - 40 & 45

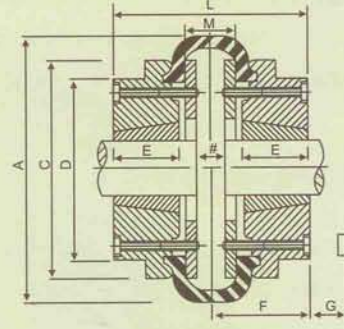

F - 50 & 60

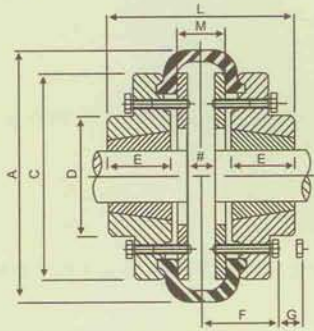

F - 70 TO 120

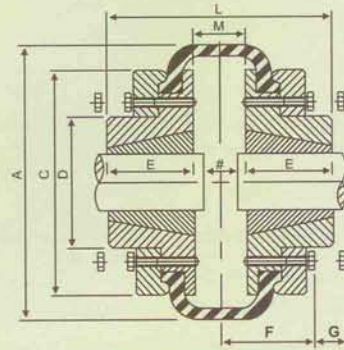

F - 140 TO 220

H TYPE

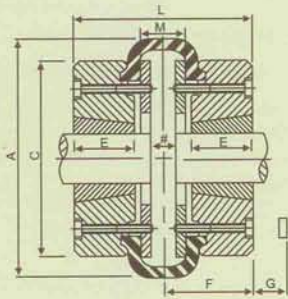

F - 40 & 45

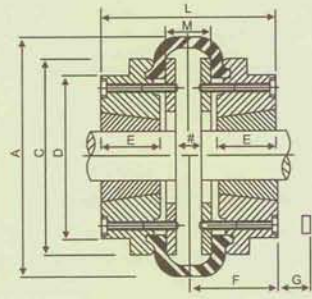

F - 50 & 60

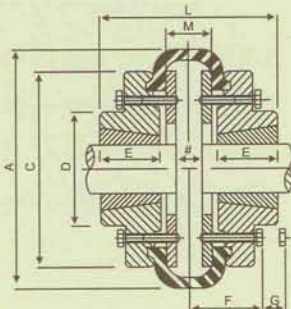

F - 70 TO 120

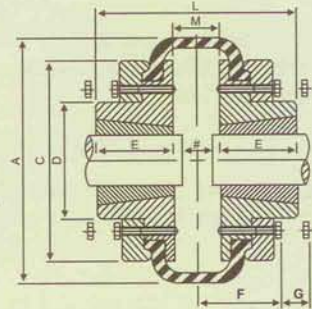

F - 140 TO 220

FENNER TYRE COUPLINGS

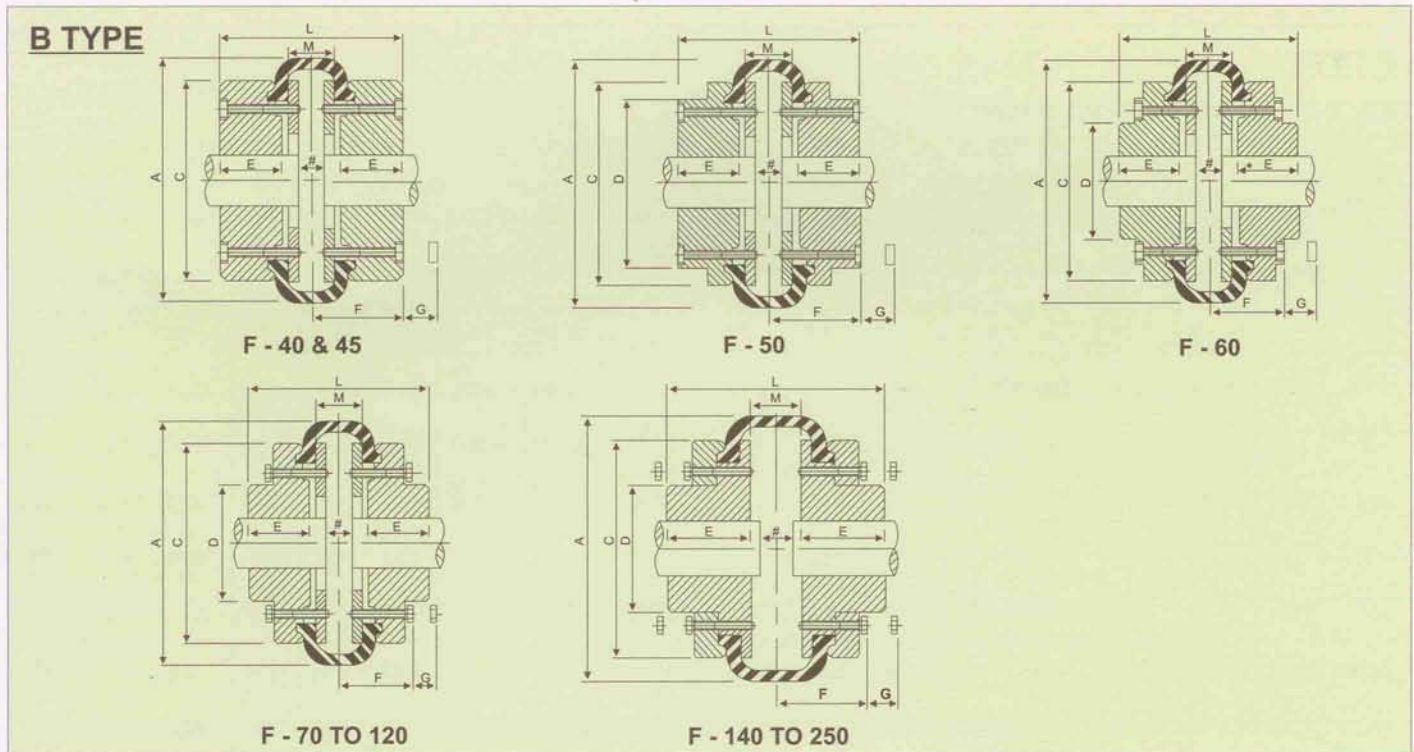

TABLE 2 : DIMENSIONS "F&H" AND "B" TYPE COUPLINGS

Size	TYPE F & H								TYPE B								A	C	‡	†	No. of screws per flange
	Bush No.	Max Bore	L	D	E	F	ξ J	* Approx Weight Kg	Max Bore	Min Bore	L	D	E	F	Set Screw on key	* Approx Weight Kg					
F40	1008	25	67	-	22	33.5	29	1.4	30	11.00	67	-	22	33.5	M5	2.0	104.0	82	43	23	4
F45	1108	28	67	-	22	33.5	29	3.0	32	11.00	73	-	25	36.5	M5	2.2	120.0	94	43	23	4
F50	1210	32	78	79.0	25	39.0	38	3.1	38	16.00	92	79	32	46.0	M5	4.0	133.5	100	43	28	4
F60	1610	42	86	103.0	25	43.0	38	5.2	48	16.00	112	73	38	43.0	M6	5.0	165.0	125	43	36	5
F70	1610	42	92	76.0	25	50.5	38	7.4	55	19.05	132	82	45	50.5	M6	8.0	197.0	144	10	42	5
F80	2012	50	111	95.0	32	53.0	47	9.2	65	25.40	149	95	51	53.0	M10	12.0	211.0	167	10	47	6
F85	2012	50	112	103.0	32	53.5	47	12.5	70	31.75	154	103	53	53.5	M12	14.0	222.0	179	13	48	6
F90	2517	60	140	110.0	45	59.5	50	15.0	76	31.75	164	110	57	59.5	M12	15.0	235.0	188	13	50	6
F100	2517	60	148	124.0	45	61.5	50	20.0	85	31.75	178	124	60	61.5	M12	21.0	254.0	216	13	58	6
F110	2517	60	140	134.0	45	63.5	50	26.5	90	31.75	180	134	65	63.5	M12	28.0	279.0	233	14	50	6
F120	3020	75	157	152.0	51	70.0	68	35.5	102	38.10	207	152	76	70.0	M12	41.0	314.0	264	14	55	6
F140	3535	90	204	194.5	89	76.0	89	67.2	120	75.00	204	195	89	76.0	M20	61.0	359.0	313	14	26	8
F160	4040	100	220	216.0	102	78.0	110	91.0	140	75.00	220	216	102	78.0	M20	86.0	402.0	345	19	16	8
F180	4545	110	258	266.0	114	94.0	126	146.0	150	75.00	258	266	114	94.0	M20	141.0	470.0	398	19	30	10
F200	4545	110	278	266.0	114	103.0	126	182.0	150	75.00	276	266	114	103.0	M20	179.0	508.0	429	19	48	12
F220	5050	125	312	267.0	127	118.0	140	320.0	160	90.00	312	267	127	118.0	M20	312.0	562.0	474	20	56	12
F250	-	-	-	-	-	-	-	-	190	100.00	360	290	150	125.0	M20	500.0	628.0	532	25	60	12

Dimensions are in millimetres

* Weights given are for min. bore complete coupling.

† M is the distance between flanges.

Shaft ends, although normally located 'M' apart - can project beyond the flanges as shown. In this event, allow sufficient space between shaft ends for the float and misalignment.

‡ G is the amount by which clamping screws need to be withdrawn to release tyre.

ξ J is the wrench clearance to allow for tightening and loosening the bush on the shaft. The use of shortened wrench will allow this dimension to be reduced.

FENNER TYRE COUPLINGS - POWER RATINGS



TABLE 3 : POWER RATINGS (kW)

Speed (rev/min)	COUPLING SIZE																
	F40	F45	F50	F60	F70	F80	F85	F90	F100	F110	F120	F140	F160	F180	F200	F220	F250
100	0.22	0.39	0.56	1.11	1.70	2.65	3.2	3.82	5.29	7.46	12.4	19.7	32.6	57.4	84	104	132
200	0.44	0.78	1.11	2.22	3.39	5.30	6.4	7.64	10.00	14.90	24.8	39.4	65.2	115	168	209	264
300	0.66	1.17	1.67	3.33	5.09	7.95	9.6	11.50	15.90	22.40	37.1	59.1	97.8	172	252	313	396
400	0.88	1.56	2.22	4.44	6.79	10.60	12.8	15.30	21.20	29.80	49.5	78.8	130	230	336	418	529
500	1.10	1.95	2.78	5.55	8.48	13.20	16.0	19.10	26.40	37.30	61.9	98.5	163	287	420	522	660
600	1.32	2.34	3.33	6.66	10.20	15.90	19.2	22.90	31.70	44.70	74.3	118	196	345	504	627	793
700	1.54	2.73	3.89	7.77	11.90	18.50	22.4	26.80	37.00	52.20	86.6	138	228	402	588	731	925
720	1.58	2.80	4.00	7.99	12.20	19.10	23.0	27.50	38.10	53.70	89.1	142	235	414	605	753	951
800	1.76	3.12	4.44	8.88	13.60	21.20	25.6	30.60	42.30	59.60	99.0	158	261	459	672	836	1057
900	1.98	3.00	5.00	9.99	15.30	23.80	28.8	34.40	47.60	67.10	111.0	177	293	517	756	940	1198
960	2.11	3.74	5.33	10.70	16.30	25.40	30.7	36.70	50.80	71.60	119.0	189	313	551	806	1003	1269
1000	2.20	3.90	5.55	11.10	17.00	26.50	32.0	38.20	52.90	74.60	124.0	197	326	574	840	1045	1322
1200	2.64	4.68	6.66	13.30	20.40	31.80	38.4	45.90	63.50	89.50	149.0	236	391	689	1008		
1400	3.08	5.46	7.77	15.50	23.80	37.10	44.8	53.50	74.00	104.00	173.0	276	456	804			
1440	3.17	5.61	7.99	16.00	24.40	38.10	46.0	55.00	76.10	107.00	178.0	284	469	827			
1600	3.52	6.24	8.88	17.80	27.10	42.40	51.2	61.20	84.60	119.00	198.0	315	522				
1800	3.96	7.02	9.99	20.00	30.50	47.70	57.6	68.80	95.20	134.00	223.0	355					
2000	4.40	7.80	11.10	22.20	33.90	53.00	64.0	76.40	106.00	149.00	248.0						
2200	4.84	8.58	12.20	24.40	37.30	58.30	70.4	84.10	116.00	164.00							
2400	5.08	9.36	13.30	26.60	40.70	63.60	76.8	91.70	127.00								
2600	5.72	10.14	14.40	28.90	44.10	68.90	83.2	99.40	137.00								
2800	6.16	10.92	15.50	31.10	47.50	74.20	89.6	107.00									
2880	6.33	11.23	16.00	32.00	48.90	76.30	92.1	110.00									
3000	6.60	11.70	16.70	33.30	50.90	79.50	96.0										
3500	7.70	13.65	19.40	38.90	59.40	The figures in heavier type are for standard motor speeds											
3600	7.92	14.04	20.00	40.00													

For speeds below 100 rev/min and intermediate speeds, use normal torque ratings.

FENNER TYRE COUPLINGS - PHYSICAL CHARACTERISTICS



TABLE 4 : PHYSICAL CHARACTERISTICS

Size	Max. Speed (rev/min)	Torque (Nm)		Moment of inertia MR ² (kgm ²)	Torsional Stiffness (Nm/°)	Maximum Misalignment (mm)	
		Nominal	Max.			Parallel	End float ±
F40	4500	21	64	0.00148	5	1.1	1.3
F45	4500	37	110	0.00250	9	1.2	1.5
F50	4500	53	160	0.00349	13	1.3	1.7
F60	4000	106	318	0.01030	26	1.6	2.0
F70	3600	162	487	0.01811	41	1.9	2.3
F80	3100	253	759	0.03679	63	2.1	2.6
F85	3000	305	915	0.05015	76	2.2	2.8
F90	2880	365	1096	0.06374	91	2.4	3.0
F100	2600	505	1517	0.11989	126	2.6	3.3
F110	2300	712	2137	0.16012	178	2.9	3.7
F120	2050	1182	3547	0.34302	296	3.2	4.0
F140	1800	1881	5642	0.69452	470	3.7	4.6
F160	1600	3113	9339	1.21767	778	4.2	5.3
F180	1500	5485	16455	2.01800	1371	4.8	6.0
F200	1300	8022	23508	4.03446	1959	5.3	6.6
F220	1100	9932	33125	8.67644	2760	5.8	7.3
F250	1000	12606	42740	16.85095	3562	6.6	8.2

Notes :

1. Maximum torque figures should be regarded as short duration overload ratings for use in such circumstances as direct-on-line starting etc.
2. All flexible tyres have an angular misalignment capacity upto 4°

TABLE 5

Coupling Size	F40*	F45*	F50*	F60*	F70	F80	F85	F90	F100	F110	F120	F140	F160	F180	F200	F220	F250	
M2 (mm)	23	23	28	36	42	47	48	50	58	50	55	26	16	30	48	56	60	
Clamping Screw Torque	Nm	15	15	15	15	24	24	32	32	32	32	35	35	35	35	35	38	38

* Hexagonal Socket Cap Head Clamping Screws on these sizes.

FENNER TYRE COUPLINGS - INSTALLATION



INSTALLATION INSTRUCTIONS

Note : Satisfactory performance depends on correct installation and maintenance. All instructions in this manual must therefore be followed carefully.

1. Thoroughly clean all components, paying particular attention to the removal of the protective coating in the bore of the flanges.
2. Fit flanges to the shafts placing the external clamp rings on the shafts. (Where Taper-Lock® flanges are used, see separate fitting instructions supplied with the Taper-Lock® Bushes). Locate flanges so that dimension M2 is obtained (see paragraph 3). Flanges with internal clamping rings should then have the clamping rings fitted, engaging only two or three of the threads of the screws at this time.
3. Bring shafts into line until dimension M2 is obtained (table 5). If shaft end float is to occur, locate the shafts at mid-position of end float when checking dimension M2. Note that shaft ends may project beyond the faces of the flanges if required. In this event, allow sufficient space between shaft ends for end float and misalignment. Flanges should be fitted flush with the end of the shaft when used with Mill-Motor flanges.
4. Check parallel alignment by laying a straight edge across the flanges at several positions around the circumference. Check angular alignment by measuring gap between flanges at several positions around the circumference. It is desirable to align the coupling as accurately as possible, particularly on high speed applications.
5. Open out tyre and fit over coupling flanges ensuring that the tyre beads seat properly on the flanges and/or clamping rings. To ensure proper seating, it may be necessary to strike the outside diameter of the tyre with a small mallet. When seated, there should be a gap between the ends of the tyre as shown in table 6.

TABLE 6

COUPLING SIZE	F40 TO F60	F70 TO F120	F140	F160 TO F180	F200 TO F250
Tyre Gap in mm.	2	3	5	6.5	8

6. Tighten clamping ring screws alternately and evenly (half turn at a time) working round each flange until the required screw torque is achieved.

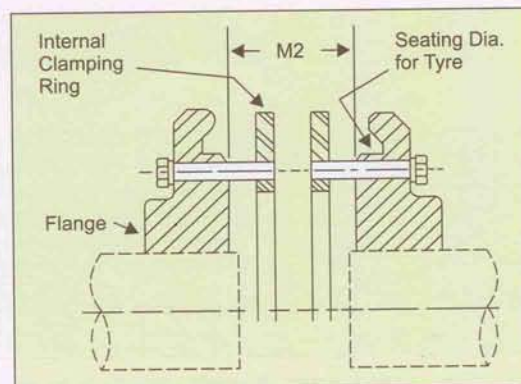
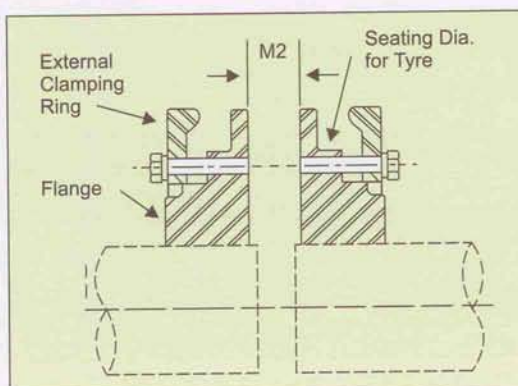

FENNER TYRE SPACER COUPLINGS

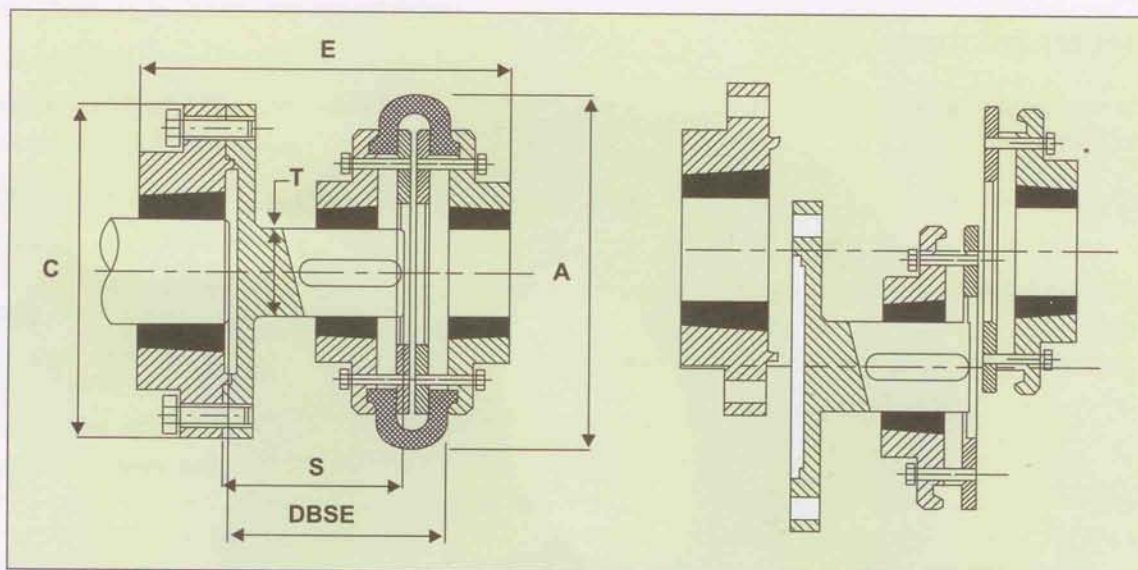

Comprising a Fenner Tyre coupling (size F40-F140) complete with a spacer flange designed for use on applications where it is an advantage to be able to move either shaft axially without disturbing the driving or driven machine; e.g. centrifugal pump rotors. Fenner Tyre spacer couplings are primarily designed for the standard distance between shaft end dimensions 100, 140 and 180 mm.

TABLE 7

SPACER SIZE	DBSE	FENNER TYRE COUPLING SIZE	SPACER BUSH SIZE	MAX. BORE	FENNER TYRE COUPLING BUSH SIZE	MAX. BORE	A	C	E	S	T
SM12	80	F40	1210	32	1008	25	104	118	134	77	25
SM12	100	F40	1210	32	1008	25	104	118	140	97	25
SM16	100	F40 *	1615	42	1008	25	104	127	170	94	32
SM16	140	F40 *	1615	42	1008	25	104	127	210	134	32
SM16	100	F50	1615	42	1210	32	133.5	127	173	94	32
SM16	140	F50	1615	42	1210	32	133.5	127	213	134	32
SM16	100	F60	1615	42	1610	42	165	127	177	94	32
SM16	140	F60	1615	42	1610	42	165	127	214	134	32
SM25	100	F70	2517	60	1610	42	197	178	180	94	42
SM25	140	F70	2517	60	1610	42	197	178	220	134	42
SM25	180	F70	2517	60	1610	42	197	178	260	174	42
SM25	100	F80	2517	60	2012	50	211	178	193	94	48
SM25	140	F80	2517	60	2012	50	211	178	233	134	48
SM25	180	F80	2517	60	2012	50	211	178	273	174	48
SM25	140	F90	2517	60	2517	60	235	178	235	134	48
SM25	180	F90	2517	60	2517	60	235	178	275	174	48
SM30	140	F100	3030	75	2517	60	254	216	269.5	134	60
SM30	180	F100	3030	75	2517	60	254	216	309.5	174	60
SM30	140	F110	3030	75	2517	60	279	216	369.5	134	60
SM30	180	F110	3030	75	2517	60	279	216	309.5	174	60
SM35	140	F120	3535	90	3020	75	314	248	297.5	134	75
SM35	180	F120	3535	90	3020	75	314	248	327.5	174	75
SM35	140	F140	3535	90	3535	90	359	248	296	134	80
SM35	180	F140	3535	90	3535	90	359	248	336	174	80

* F40 'B' Flange must be used to fit spacer shaft.



Using Fenner Taper Taper-Lock® Bushes, it is possible for unskilled labour to achieve 'shrink fit' of pulleys, coupling etc., onto shafts using only a hexagonal wrench.

The arrangement of half-threaded holes and longitudinally split tapered bushes ensures maximum grip and fast, easy fitting. Tightening of the screws into the threaded holes in the hub forces the bush into the taper bored components, thereby effectively contracting the bore of the Taper-Lock® Bush until the equivalent of a 'shrink fit' is obtained.

Taper-Lock® Bushes are suitable for metric as well as imperial shafts.

ADVANTAGES

- No reboring and keywaying costs.
- Saves time and cost in fitting.
- Eliminates precision taper fitting keys.
- 239 bush size/bore combinations are available.
- Interchangeable between many products.
- Taper bored components can be transferred to other diameter shafts by fitting alternative bore bushes.
- Convenience in dismantling for maintenance and component replacement.
- Accommodates shaft limits of +0.051 mm/-0.127mm.

The benefits of using Taper-Lock® Bushes can be extended to include components which have a parallel bore by incorporating Taper-Lock® Adaptors, Taper-Lock® Bolt-on Hubs or Taper-Lock® weld-on Hubs.

FENNER TAPERLOCK® BUSHES



TABLE 8
METRIC BORES AND KEYWAYS

Bore Dia.	Keyway		Shallow Keyway Depth	Catalogue Code Group 029 ...																
	Width	Depth		1008	1108	1210	1215	1310	1610	1615	2012	2517	2525	3020	3030	3525	3535	4040	4545	5050
9	3	1.4	-	...009	009															
10	3	1.4	-	...010	010															
11	4	1.8	-	...011	011	011	011													
12	4	1.8	-	...012	012	012	012													
14	5	2.3	-	...014	014	014	014	014	014	014	014									
16	5	2.3	-	...016	016	016	016	016	016	016	016	016								
18	6	2.8	-	...018	018	018	018	018	018	018	018	018	018							
19	6	2.8	-	...019	019	019	019	019	019	019	019	019	019	019						
20	6	2.8	-	...020	020	020	020	020	020	020	020	020	020	020						
22	6	2.8	-	...022	022	022	022	022	022	022	022	022	022	022						
24	8	3.3	1.3	...024*	024	024	024	024	024	024	024	024	024	024						
25	8	3.3	1.3	...025*	025	025	025	025	025	025	025	025	025	025	025					
28	8	3.3	1.3		028*	028	028	028	028	028	028	028	028	028	028					
30	8	3.3	-			030	030	030	030	030	030	030	030	030	030					
32	10	3.3	1.3			032*	032*	032	032	032	032	032	032	032	032					
35	10	3.3	1.3					035*	035	035	035	035	035	035	035	035	035	035	035	035
38	10	3.3	-						038	038	038	038	038	038	038	038	038	038	038	038
40	12	3.3	1.3						040*	040*	040	040	040	040	040	040	040	040	040	040
42	12	3.3	1.3						042*	042*	042	042	042	042	042	042	042	042	042	042
45	14	3.8	-								045	045	045	045	045	045	045	045	045	045
48	14	3.8	-								048	048	048	048	048	048	048	048	048	048
50	14	3.8	2.8							050*	050	050	050	050	050	050	050	050	050	050
55	16	4.3	-									055	055	055	055	055	055	055	055	055
60	18	4.4	-									060	060	060	060	060	060	060	060	060
65	18	4.4	-										065	065	065	065	065	065	065	065
70	20	4.9	-											070	070	070	070	070	070	070
75	20	4.9	-											075	075	075	075	075	075	075
80	22	5.4	-												080	080	080	080	080	080
85	22	5.4	-												085	085	085	085	085	085
90	25	5.4	3.4												090*	090*	090	090	090	090
95	25	5.4	-														095	095	095	095
100	28	6.4	5.4														100*	100	100	100
105	28	6.4	-																105	105
110	28	6.4	-																110	110
115	32	7.4	-																	115
120	32	7.4	-																	120
125	32	7.4	-																	125
Nominal dia at large end of Taper				35.0	38.0	47.5	47.5	51.0	57.0	57.0	70.0	85.5	85.5	108.0	108.0	127.0	127.0	146.0	162.0	177.5
Approx. Mass of Bush (Kg)				0.1	0.1	0.2	0.3	0.3	0.3	0.5	0.7	1.5	1.9	2.7	3.6	3.8	5.0	7.7	10	14



Dimensions in millimeters

Keyways are British Standard Metric B.S. 4235: Part 1:1972 and conform to I.S.O. recommendations except for the bore sizes marked * which are shallower.

Where a key is to be used it should be parallel and side fitting with top clearance. Depth of keyway is measured at CENTRE.

Note : Taper-Lock® Bushes with imperial bores can also be supplied. Please consult Fenner.

PRODUCT RANGE



Fenner (India) Limited

Corporate Office : Khivraj Complex II, V Floor, 480, Anna Salai, Nandanam, Chennai-600 035

Tel: 24312450 to 57, Fax: 044 -24349016, 24320193.

E.mail: ptd_mhq@fennermail.com Website: www.fennerindia.com

Registered Office: 3, Madurai - Melakkal Road, Kochadai, Madurai - 625 016. Tel: 2383801, 2383802

Fax : 0452 -2383822.

Branches at : **Ahmedabad :** Shreeji House, 3rd Floor, Behind M.J.Library, Ellis Bridge, Ahmedabad - 386 006. Tel: 079-26578572, 26578590. **Bangalore :** No.20, New Timber Yard Layout, Mysore Road, Bangalore - 560 026. Tel: 080-26756333, Fax : 080-26756333. **Indore:** 24, Sitabagh Colony, Dhenu Market, Indore - 452 001, Tel: 0731 -2538248. Fax: 0731-4043935 **Jaipur :** A-21, Opp. State Bank of India, Bais Godown, Industrial Area, Jaipur-302006, Tel:0141-2211075, 93148 70878. **Kanpur :** 112/371 (A), Swaroop Nagar, Kanpur - 208 002, Tel : 0512-2525304, 2540915, Fax: 0512-2294071. **Kochi :** 32/364-A,A-I,A-II, Masjid Road, Palarivattom, Kochi-682025 Tel : 0484-3242480, 98950 71066. **Kolkata :** 56-D, Mirza Ghalib Street, Kolkata-700 016. Tel : 033-22297880, 22298791, 22298792, Fax : 033 -22290701, 22297880. **Ludhiana :** B-XVII/ 2820/48, Opp to Adam Park, Jammu Colony, Link Road, Ludhiana -141 003. Tel : 0161-2410214, Telefax:0161-2443791. **Madurai :** 117/6E, Madurai - Usilampatti Road, Meenakshipuram, Madurai-625 016. Tel : 0452-2383920, Telefax: 0452-2383921. **Mumbai :** 19/21, Manohardas Street, P.B. No.1307, Opp. G.P.O., Fort, Mumbai-400 001. Tel : 022-22695040, 22696329, 22697041, Fax : 022-22695199. **New Delhi :** 2nd Floor, Delite Theatre Building, Asaf Ali Road, New Delhi - 110002. Tel:011 - 23 24 31 12 , 23 24 31 13. Fax : 011-23 24 31 14 . **Secunderabad :** No.156/8, Plot No.147, A. P. Text Book Colony, Transport Road, Karkhana, Secunderabad - 500 015 Tel : 040-27845443, 27845444, Fax : 2784 5425



All rights reserved by Fenner (India) Limited. No portion of the Catalogue can be reproduced in any form without authorisation of the copyright owner.

14/32/2008-5k